

AF09 ... AF38 4-pole Contactors up to 55 A, AC-1

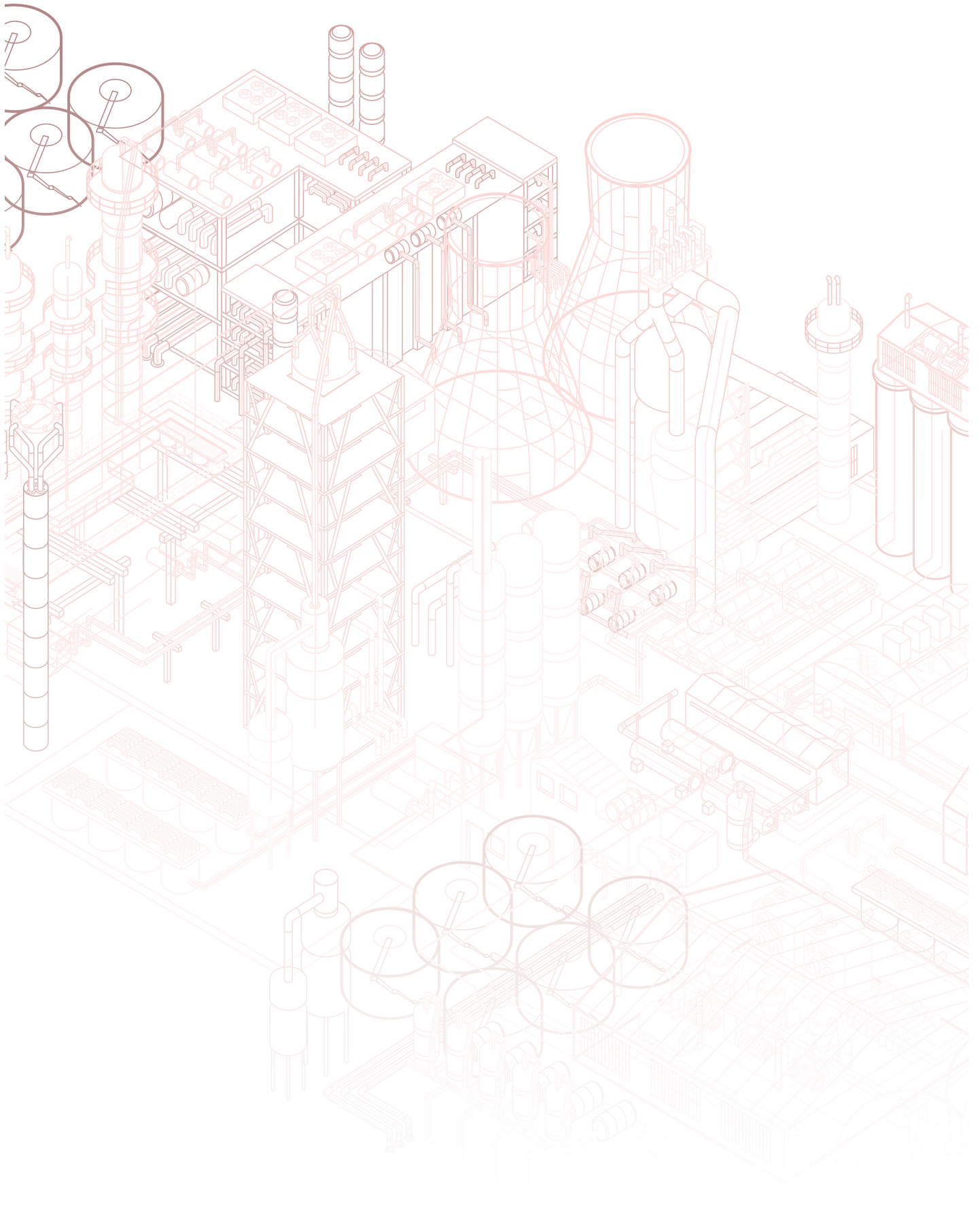

Overview	3
Ordering Details	
– AF09 ... AF38 4-pole Contactors	4
– AF09Z ... AF38Z 4-pole Contactors - Low Consumption	5
Technical Data	6
Main Accessory Fitting Details	9
Accessory Ordering Details and Technical Data	10
Terminal Marking and Positioning	15
Dimensions	17
Index	19



4-pole Contactors

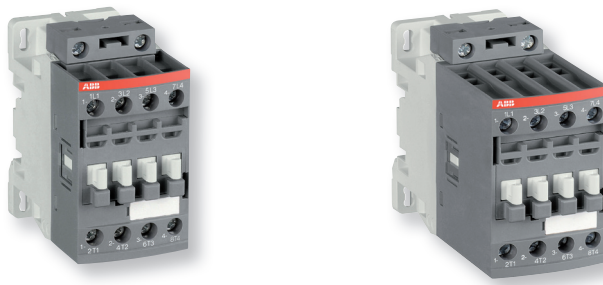

AC / DC control voltage

AF09	AF16	AF26	AF38
AF09-40-00	AF16-40-00	AF26-40-00	AF38-40-00
AF09-22-00	AF16-22-00	AF26-22-00	AF38-22-00

Switching of Resistive Circuits

	IEC	AC-1	Rated operational current	$\theta \leq 40\text{ }^{\circ}\text{C}$	690 V
				$\theta \leq 60\text{ }^{\circ}\text{C}$	690 V
				$\theta \leq 70\text{ }^{\circ}\text{C}$	690 V
With conductor cross-sectional area					
	UL/CSA	General use rating		600 V AC	
		With conductor cross-sectional area			

25 A	30 A	45 A	55 A
25 A	30 A	40 A	45 A
22 A	26 A	32 A	37 A
4 mm ²	6 mm ²	10 mm ²	16 mm ²
25 A	30 A	45 A	55 A
AWG 10	AWG 10	AWG 8	AWG 6

Main Accessories

Auxiliary contact blocks

Front mounting

Side mounting

Interlocks

Mechanical / electrical

Mechanical

1-pole CA4-10 or CA4-01, CC4-10 or CC4-01
4-pole CA4
2-pole CAT4-11 (with coil front connection)
2-pole CAL4-11
VEM4 including VM4 mechanical interlock unit and VE4 electrical interlock block with A2-A2 connection
VM4 including 2 fixing clips

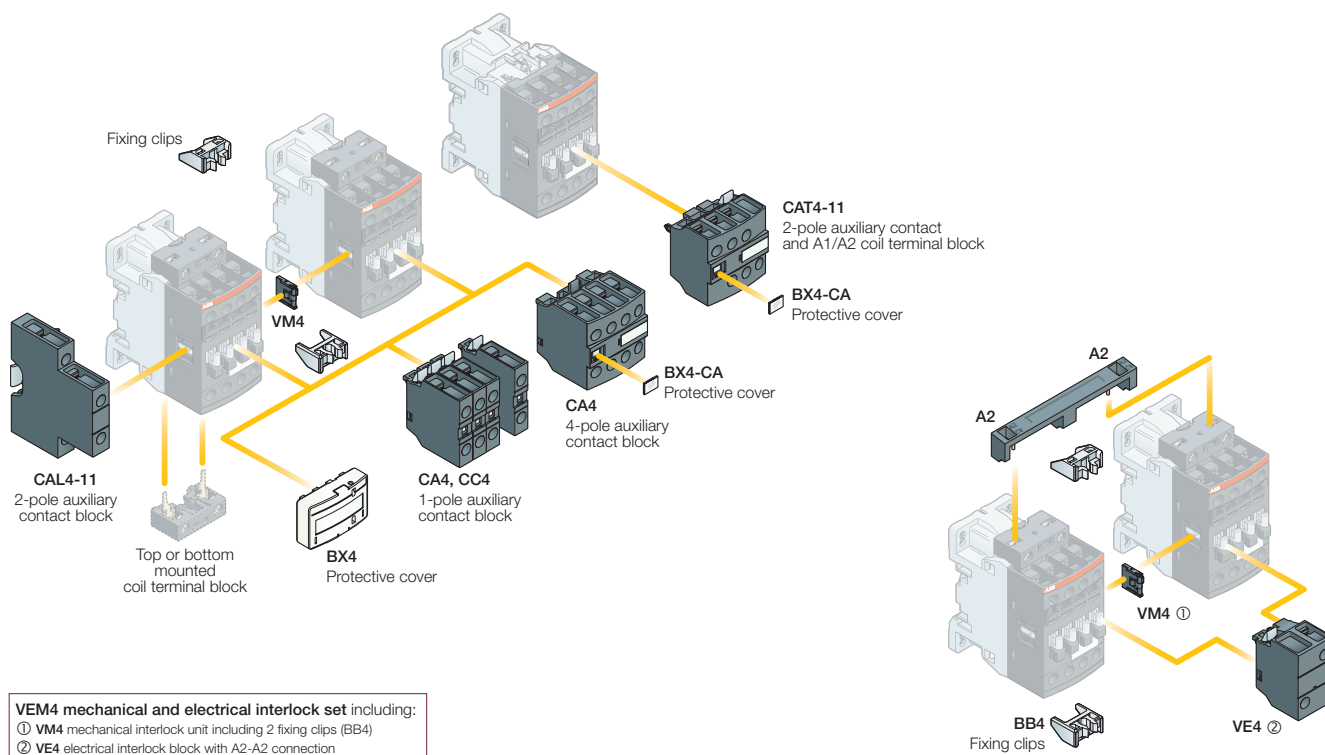

VEM4 mechanical and electrical interlock set including:

- ① VM4 mechanical interlock unit including 2 fixing clips (BB4)
- ② VE4 electrical interlock block with A2-A2 connection

AF09 ... AF38 4-pole Contactors

AC / DC Operated - with Screw Terminals

Catalogue Page 1SBC 101 242 S0201



AF09-40-00



AF26-40-00

Application

AF09 ... AF38 4-pole contactors are used for controlling power circuits up to 690 V AC and 440 V DC. They are mainly used for controlling non-inductive or slightly inductive loads (i.e. resistance furnaces...).

Description

- **AF09 ... AF38** contactors include an electronic coil interface accepting a wide control voltage U_c min. ... U_c max. Only four coils cover control voltages between 24...500 V 50/60 Hz or 20...500 V DC
- **AF** contactors can manage large control voltage variations. One coil (e.g. 100...250 V 50/60 Hz - DC) can be used for different control voltages used worldwide without any coil change
- **AF** contactors have built-in surge protection and do not require additional surge suppressors.

Note: - **AF...-...-11** not suitable for a direct control by PLC-output.

- **AF...-...-11** type available in some countries: please consult your ABB representative.

Ordering Details

IEC	UL/CSA	Control voltage		Auxiliary contacts fitted	Type	Order code	Weight
AC-1 Rated current	General use rating	U_c min. ... U_c max.					Pack ^(ing) 1 piece kg
$\theta \leq 40^\circ\text{C}$ A	600 V AC	V 50/60 Hz	V DC				

4 N.O. Main Poles

25	25	24...60	20...60	0 0	AF09-40-00-11	1SBL 137 201 R1100	0.270
		48...130	48...130	0 0	AF09-40-00-12	1SBL 137 201 R1200	0.270
		100...250	100...250	0 0	AF09-40-00-13	1SBL 137 201 R1300	0.270
		250...500	250...500	0 0	AF09-40-00-14	1SBL 137 201 R1400	0.310
30	30	24...60	20...60	0 0	AF16-40-00-11	1SBL 177 201 R1100	0.270
		48...130	48...130	0 0	AF16-40-00-12	1SBL 177 201 R1200	0.270
		100...250	100...250	0 0	AF16-40-00-13	1SBL 177 201 R1300	0.270
		250...500	250...500	0 0	AF16-40-00-14	1SBL 177 201 R1400	0.310
45	45	24...60	20...60	0 0	AF26-40-00-11	1SBL 237 201 R1100	0.360
		48...130	48...130	0 0	AF26-40-00-12	1SBL 237 201 R1200	0.360
		100...250	100...250	0 0	AF26-40-00-13	1SBL 237 201 R1300	0.360
		250...500	250...500	0 0	AF26-40-00-14	1SBL 237 201 R1400	0.400
55	55	24...60	20...60	0 0	AF38-40-00-11	1SBL 297 201 R1100	0.360
		48...130	48...130	0 0	AF38-40-00-12	1SBL 297 201 R1200	0.360
		100...250	100...250	0 0	AF38-40-00-13	1SBL 297 201 R1300	0.360
		250...500	250...500	0 0	AF38-40-00-14	1SBL 297 201 R1400	0.400

2 N.O. + 2 N.C. Main Poles

25	25	24...60	20...60	0 0	AF09-22-00-11	1SBL 137 501 R1100	0.270
		48...130	48...130	0 0	AF09-22-00-12	1SBL 137 501 R1200	0.270
		100...250	100...250	0 0	AF09-22-00-13	1SBL 137 501 R1300	0.270
		250...500	250...500	0 0	AF09-22-00-14	1SBL 137 501 R1400	0.310
30	30	24...60	20...60	0 0	AF16-22-00-11	1SBL 177 501 R1100	0.270
		48...130	48...130	0 0	AF16-22-00-12	1SBL 177 501 R1200	0.270
		100...250	100...250	0 0	AF16-22-00-13	1SBL 177 501 R1300	0.270
		250...500	250...500	0 0	AF16-22-00-14	1SBL 177 501 R1400	0.310
45	45	24...60	20...60	0 0	AF26-22-00-11	1SBL 237 501 R1100	0.360
		48...130	48...130	0 0	AF26-22-00-12	1SBL 237 501 R1200	0.360
		100...250	100...250	0 0	AF26-22-00-13	1SBL 237 501 R1300	0.360
		250...500	250...500	0 0	AF26-22-00-14	1SBL 237 501 R1400	0.400
55	55	24...60	20...60	0 0	AF38-22-00-11	1SBL 297 501 R1100	0.360
		48...130	48...130	0 0	AF38-22-00-12	1SBL 297 501 R1200	0.360
		100...250	100...250	0 0	AF38-22-00-13	1SBL 297 501 R1300	0.360
		250...500	250...500	0 0	AF38-22-00-14	1SBL 297 501 R1400	0.400

Main Dimensions mm, inches

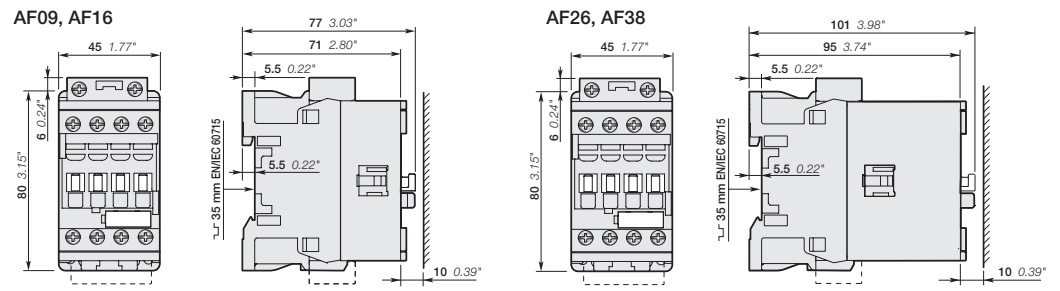

AF09Z ... AF38Z 4-pole Contactors - Low Consumption

Catalogue Page 1SBC 101 073 S0201

AC / DC Operated - with Screw Terminals



AF09Z-40-00



AF26Z-40-00



Application

AF09Z ... AF38Z 4-pole contactors are used for controlling power circuits up to 690 V AC and 440 V DC. They are mainly used for controlling non-inductive or slightly inductive loads (i.e. resistance furnaces...).

Description

- **AF09Z ... AF38Z** contactors include an electronic coil interface accepting a wide control voltage U_c min. ... U_c max and managing large control voltage variations.
- **AF..Z** contactors cover control voltages between 24...250 V 50/60 Hz or 12...250 V DC
- **AF..Z** contactors allow direct control by PLC-output ≥ 24 V DC 500 mA and obtain a reduced holding coil consumption.
- **AF..Z** contactors withstand short voltage dips and voltage sags (SEMI F47-0706 compliance)
- **AF..Z** contactors have built-in surge protection and do not require additional surge suppressors.

Ordering Details

IEC	UL/CSA	Control voltage	Auxiliary contacts fitted	Type	Order code	Weight
AC-1	General use rating	U_c min. ... U_c max.				
$\theta \leq 40^\circ\text{C}$	600 V AC	V 50/60 Hz V DC	 			Pack ^(ing) 1 piece kg

4 N.O. Main Poles

Rated current (A)	UL/CSA (A)	Control voltage (V)	Auxiliary contacts	Type	Order code	Weight (kg)	
25	25	-	12...20	0 0	AF09Z-40-00-20	1SBL 136 201 R2000	0.310
		24...60	20...60	0 0	AF09Z-40-00-21	1SBL 136 201 R2100	0.310
		48...130	48...130	0 0	AF09Z-40-00-22	1SBL 136 201 R2200	0.310
		100...250	100...250	0 0	AF09Z-40-00-23	1SBL 136 201 R2300	0.310
30	30	-	12...20	0 0	AF16Z-40-00-20	1SBL 176 201 R2000	0.310
		24...60	20...60	0 0	AF16Z-40-00-21	1SBL 176 201 R2100	0.310
		48...130	48...130	0 0	AF16Z-40-00-22	1SBL 176 201 R2200	0.310
		100...250	100...250	0 0	AF16Z-40-00-23	1SBL 176 201 R2300	0.310
45	45	-	12...20	0 0	AF26Z-40-00-20	1SBL 236 201 R2000	0.400
		24...60	20...60	0 0	AF26Z-40-00-21	1SBL 236 201 R2100	0.400
		48...130	48...130	0 0	AF26Z-40-00-22	1SBL 236 201 R2200	0.400
		100...250	100...250	0 0	AF26Z-40-00-23	1SBL 236 201 R2300	0.400
55	55	-	12...20	0 0	AF38Z-40-00-20	1SBL 296 201 R2000	0.400
		24...60	20...60	0 0	AF38Z-40-00-21	1SBL 296 201 R2100	0.400
		48...130	48...130	0 0	AF38Z-40-00-22	1SBL 296 201 R2200	0.400
		100...250	100...250	0 0	AF38Z-40-00-23	1SBL 296 201 R2300	0.400

2 N.O. + 2 N.C. Main Poles

Rated current (A)	UL/CSA (A)	Control voltage (V)	Auxiliary contacts	Type	Order code	Weight (kg)	
25	25	-	12...20	0 0	AF09Z-22-00-20	1SBL 136 501 R2000	0.310
		24...60	20...60	0 0	AF09Z-22-00-21	1SBL 136 501 R2100	0.310
		48...130	48...130	0 0	AF09Z-22-00-22	1SBL 136 501 R2200	0.310
		100...250	100...250	0 0	AF09Z-22-00-23	1SBL 136 501 R2300	0.310
30	30	-	12...20	0 0	AF16Z-22-00-20	1SBL 176 501 R2000	0.310
		24...60	20...60	0 0	AF16Z-22-00-21	1SBL 176 501 R2100	0.310
		48...130	48...130	0 0	AF16Z-22-00-22	1SBL 176 501 R2200	0.310
		100...250	100...250	0 0	AF16Z-22-00-23	1SBL 176 501 R2300	0.310
45	45	-	12...20	0 0	AF26Z-22-00-20	1SBL 236 501 R2000	0.400
		24...60	20...60	0 0	AF26Z-22-00-21	1SBL 236 501 R2100	0.400
		48...130	48...130	0 0	AF26Z-22-00-22	1SBL 236 501 R2200	0.400
		100...250	100...250	0 0	AF26Z-22-00-23	1SBL 236 501 R2300	0.400
55	55	-	12...20	0 0	AF38Z-22-00-20	1SBL 296 501 R2000	0.400
		24...60	20...60	0 0	AF38Z-22-00-21	1SBL 296 501 R2100	0.400
		48...130	48...130	0 0	AF38Z-22-00-22	1SBL 296 501 R2200	0.400
		100...250	100...250	0 0	AF38Z-22-00-23	1SBL 296 501 R2300	0.400

Note: Only AF..Z contactors with DC control voltage 12...20 V DC need to respect the connection polarities indicated close to the coil terminals: A1+ for the positive pole and A2- for the negative pole

Main Dimensions mm, inches

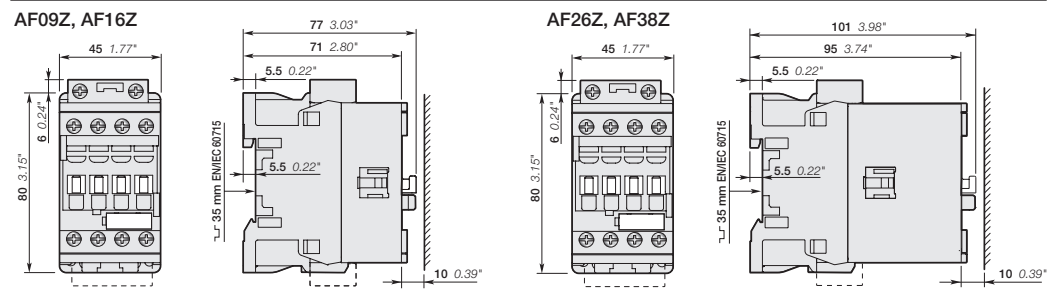

AF09 ... AF38 4-pole Contactors

AC / DC Operated - with Screw Terminals

Catalogue Page 1SBC 101 109 S0201

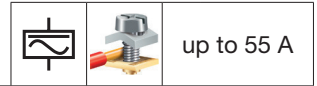

Main Pole - Utilization Characteristics according to IEC

Contactor types		AF09	AF16	AF26	AF38
Standards		IEC 60947-1 / 60947-4-1 and EN 60947-1 / 60947-4-1			
Rated operational voltage U_e max.		690 V			
Rated frequency limits		25 ... 400 Hz			
Conventional free-air thermal current I_{th}		35 A	35 A	55 A	55 A
acc. to IEC 60947-4-1, open contactors, $\theta \leq 40$ °C					
with conductor cross-sectional area		6 mm ²	6 mm ²	16 mm ²	16 mm ²
AC-1 Utilization category					
for air temperature close to contactor					
I_e / AC-1 rated operational current	$\theta \leq 40$ °C	25 A	30 A	45 A	55 A
U_e max. ≤ 690 V, 50/60 Hz	$\theta \leq 60$ °C	25 A	30 A	40 A	45 A
	$\theta \leq 70$ °C	22 A	26 A	32 A	37 A
with conductor cross-sectional area		4 mm ²	6 mm ²	10 mm ²	16 mm ²
Short-circuit protection					
for contactors without thermal O/L relay - Motor protection excluded					
$U_e \leq 500$ V AC - gG type fuse		25 A	32 A	50 A	63 A
Rated short-time withstand current I_{cw}	1 s	300 A	300 A	450 A	450 A
at 40 °C ambient temperature, in free air from a cold state	10 s	150 A	150 A	300 A	300 A
	30 s	80 A	80 A	225 A	225 A
	1 min	60 A	60 A	150 A	150 A
	15 min	35 A	35 A	55 A	55 A
Heat dissipation per pole	I_e / AC-1	0.8 W	1.2 W	1.6 W	2.3 W
Max. electrical switching frequency	AC-1	600 cycles/h			

Main Pole - Utilization Characteristics according to UL / CSA

Contactor types		AF09	AF16	AF26	AF38
Standards		UL 508, CSA C22.2 N°14			
Rated operational voltage U_e max.		600 V			
UL General use rating					
600 V AC		25 A	30 A	45 A	55 A
With conductor cross-sectional area		AWG 10	AWG 10	AWG 8	AWG 6
80 V DC - 1-pole for 4 N.O. main poles		25 A	30 A	45 A	55 A
With conductor cross-sectional area		AWG 10	AWG 10	AWG 8	AWG 6
80 V DC - 1-pole for 2 N.O. / 2 N.C. main poles		20 A	20 A	45 A	55 A
With conductor cross-sectional area		AWG 12	AWG 12	AWG 8	AWG 6
Max. electrical switching frequency					
for general use		600 cycles/h			

Remark for 4-pole contactors fitted with 2 N.O. + 2 N.C. main poles

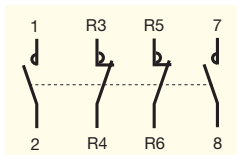

These contactors are suitable for controlling 2 separate circuits, i.e. 2 loads with 2 separate supplies, or 1 circuit comprising 2 separate loads with a single supply (see diagrams below). When the contactor operates there is no mechanical overlapping between the N.O. poles and the N.C. poles: BREAK before MAKE.



These contactors are not suitable for a reversing starter or for controlling a single load from 2 separate supplies.

Block diagrams

- Single supply and 2 separate loads

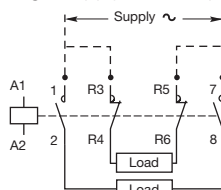

- 2 separate supplies and 2 separate loads

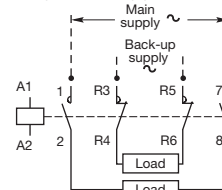

AF09 ... AF38 4-pole Contactors

AC / DC Operated - with Screw Terminals

Catalogue Page 1SBC 101 109 S0201



General Technical Data

Contactor types	AF09	AF16	AF26	AF38	
Rated insulation voltage U_i acc. to IEC 60947-4-1 acc. to UL	690 V 600 V				
Rated impulse withstand voltage U_{imp}	6 kV				
Electromagnetic compatibility	Devices complying with IEC 60947-1 / EN 60947-1 - Environment A				
Ambient air temperature close to contactor					
Operation in free air	-40 ... +70 °C				
Storage	-60 ... +80 °C				
Climatic withstand	Category B according to IEC 60947-1 Annex Q				
Operating altitude	≤ 3000 m				
Mechanical durability					
Number of operating cycles	10 millions operating cycles				
Max. switching frequency	3600 cycles/h				
Shock withstand acc. IEC 60068-2-27 and EN 60068-2-27					
Mounting position 1	Closed or open position	Shock direction 1/2 sinusoidal shock for 11 ms: no change in contact position			
<p>4 N.O. main poles</p> <p>2 N.O. + 2 N.C. main poles</p>	A	30 g			
	B1	25 g Closed position / 5 g Open position			
	B2	15 g			
	C1	25 g			
	C2	25 g			
	A	30 g	30 g Closed position / 25 g Open position		
	B1	25 g Closed position / 5 g Open position	25 g Closed position / 5 g Open position		
	B2	15 g	15 g Closed position / 10 g Open position		
C1	25 g	25 g Closed position / 20 g Open position			
C2	25 g	25 g Closed position / 20 g Open position			
Vibration withstand acc. to IEC 60068-2-6	5 ... 300 Hz 4 g Closed position / 2 g Open position				

Magnet System Characteristics

Contactor types	AF09	AF16	AF26	AF38
Coil operating limits acc. to IEC 60947-4-1				
	AC supply	at $\theta \leq 60$ °C $0.85 \times U_c$ min ... $1.1 \times U_c$ max at $\theta \leq 70$ °C $0.85 \times U_c$ min ... U_c max		
	DC supply	at $\theta \leq 60$ °C $0.85 \times U_c$ min ... $1.1 \times U_c$ max at $\theta \leq 70$ °C (AF) $0.85 \times U_c$ min ... U_c max - (AF.Z) $0.85 \times U_c$ min ... $1.1 \times U_c$ max		
AC control voltage 50/60 Hz	Rated control circuit voltage U_c Coil consumption	24 ... 500 V AC Average pull-in value (AF) 50 VA - (AF.Z) 16 VA Average holding value (AF) 2.2 VA / 2 W - (AF.Z) 1.7 VA / 1.5 W		
DC control voltage	Rated control circuit voltage U_c Coil consumption	12 ... 500 V DC Average pull-in value (AF) 50 W - (AF.Z) 12 ... 16 W Average holding value (AF) 2 W - (AF.Z) 1.7 W		
PLC-Output control	(AF.Z) ≥ 500 mA 24 V DC			
Drop-out voltage in % of U_c min.	≤ 60 % U_c min			
Voltage sag immunity according to SEMI F47-0706	(AF.Z) conditions of use on request			
Dips withstand (level 0% according to IEC 61000-4-11) -20 °C ≤ θ ≤ +60 °C	(AF.Z) 22 ms average for $U_c = 24$... 250 V 50/60Hz			
Operating time between coil energization and: between coil de-energization and:	N.O. contact closing	40 ... 95 ms		
	N.C. contact opening	38 ... 90 ms		
	N.O. contact opening	11 ... 95 ms		
	N.C. contact closing	13 ... 98 ms		

Mounting Characteristics

Contactor types	AF09	AF16	AF26	AF38
Mounting positions				
Mounting distances	Max. add-on N.C. auxiliary contacts: see accessory fitting details for a 4-pole contactor AF09 ... AF38			
Fixing	The contactors can be assembled side by side.			
on rail according to IEC 60715, EN 60715	35 x 7.5 mm or 35 x 15 mm			
by screws (not supplied)	2 x M4 screws placed diagonally			











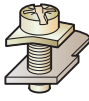
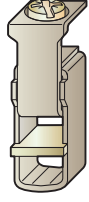



AF09 ... AF38 4-pole Contactors

AC / DC Operated - with Screw Terminals

Catalogue Page 1SBC 101 109 S0201



Connecting Characteristics

Contactor types	AF09	AF16	AF26	AF38
Main terminals				
	Screw terminals with cable clamp		Screw terminals with double connector 2 x (5.5 width x 6.8 depth)	
Connecting capacity (min. ... max.)				
Main conductors (poles)				
 Rigid	solid ($\leq 4 \text{ mm}^2$)	1 x	1 ... 6 mm ²	1.5 ... 16 mm ²
	stranded ($\geq 6 \text{ mm}^2$)	2 x	1 ... 6 mm ²	1.5 ... 16 mm ²
	Flexible with non insulated ferrule	1 x	0.75 ... 6 mm ²	1.5 ... 16 mm ²
	Flexible with insulated ferrule	2 x	0.75 ... 6 mm ²	1.5 ... 16 mm ²
	Flexible with insulated ferrule	1 x	0.75 ... 4 mm ²	1.5 ... 16 mm ²
	Flexible with insulated ferrule	2 x	0.75 ... 2.5 mm ²	1.5 ... 16 mm ²
	Bars or lugs	L <	9.6 mm	-
Capacity according to UL/CSA		1 or 2 x	AWG 16 ... 10	AWG 16 ... 6
Stripping length			10 mm	12 mm
Auxiliary conductors				
	Rigid solid	1 x	1 ... 2.5 mm ²	
	Rigid solid	2 x	1 ... 2.5 mm ²	
	Flexible with non insulated ferrule	1 x	0.75 ... 2.5 mm ²	
	Flexible with non insulated ferrule	2 x	0.75 ... 2.5 mm ²	
	Flexible with insulated ferrule	1 x	0.75 ... 2.5 mm ²	
	Flexible with insulated ferrule	2 x	0.75 ... 1.5 mm ²	
	Bars or lugs	L <	8 mm	
Capacity according to UL/CSA		1 or 2 x	AWG 18 ... 14	
Stripping length			10 mm	
Degree of protection				
acc. to IEC 60947-1 / EN 60947-1 and IEC 60529 / EN 60529				
Main terminals			IP20	
Coil terminals			IP20	
Screw terminals				
(delivered in open position, screws of unused terminals must be tightened)				
Main terminals			M3.5	M4.5
Coil terminals			M3.5	
Screwdriver type				
Flat Ø 5.5 / Pozidriv 2				
Tightening torque				
Main pole terminals			1.5 Nm / 13 lb.in	2.5 Nm / 22 lb.in
Coil terminals			1.2 Nm / 11 lb.in	

AF09 ... AF38 4-pole Contactors

Main Accessories

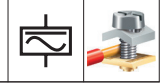

Accessory fitting details for a 4-pole contactor AF09 ... AF38

Many configurations of accessories are possible depending on whether these are front-mounted or side-mounted.

Contactor types	Main poles	Built-in auxiliary contacts	Front-mounted accessories			Electrical and mechanical interlock set (between 2 contactors)	Side-mounted accessories	
			Auxiliary contact blocks				Auxiliary contact blocks	
			1-pole CA4	2-pole CAT4-11	4-pole CA4	VEM4	Left side	Right side
			1-pole CC4				2-pole CAL4-11	
			Max. add-on N.C. auxiliary contacts: 4 N.C. max. on positions 1, 2, 3, 4 and 3 N.C. max. on positions 1 ±30°, 5					
AF09, AF16	4	0 0 0	4 max.	or 1	or 1	-	+ 1	-
			2 max.	or 1	-	-	+ 1	+ 1
			3 max.	-	-	+ 1	+ 1	or 1
			Max. add-on N.C. auxiliary contacts: 3 N.C. max. on positions 1, 2, 3, 4 and 2 N.C. max. on positions 1 ±30°, 5					
AF26, AF38	4	0 0 0	4 max.	or 1	or 1	-	+ 1	-
			2 max.	or 1	-	-	+ 1	+ 1
			3 max.	-	-	+ 1	+ 1	or 1
AF09, AF16	2	2 0 0	4 max.	or 1	or 1	-	+ 1	-
AF26, AF38	2	2 0 0	2 max.	or 1	-	-	+ 1	+ 1

Mounting positions



Contactors and main accessories (other accessories available)

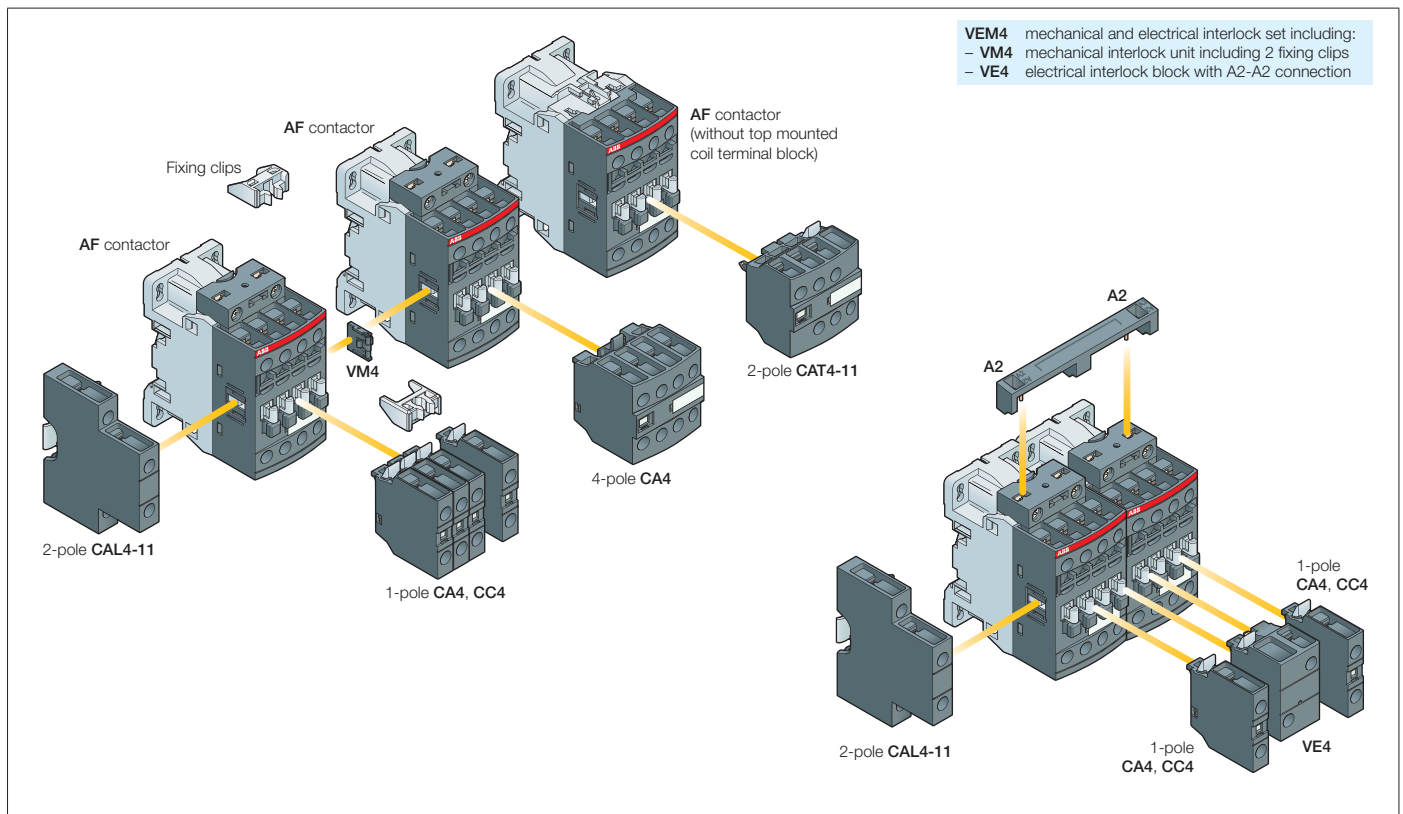



CA4-10



CA4-22E



CAL4-11



CAT4-11E

Application

The auxiliary contact blocks are used for the operation of auxiliary circuits and control circuits.

Description

Types of auxiliary contact blocks for standard industrial environments:

- **CA4** 1 or 4-pole block, front-mounted, instantaneous with N.O., N.C. contacts
- **CC4** 1-pole block, front-mounted, with N.O. leading contact or N.C. lagging contact
- **CAT4** 2-pole block, front-mounted, instantaneous N.O. + N.C. contacts with A1 / A2 coil terminal connection on front face
- **CAL4** 2-pole block instantaneous N.O. + N.C. contacts clipped onto the right and/or left side of the contactors.

The auxiliary contact blocks are equipped with screw type connecting terminals delivered open, protected against accidental direct contact and bear the corresponding function marking.

Fitting Details - For each contactor, refer to "Accessory Fitting Details" table.

Ordering Details

For contactors	Auxiliary contacts	Type	Order code	Pack ^(ing) pieces	Weight kg (1 pce)

Front-mounted instantaneous auxiliary contact blocks

AF09 ... AF38...-40-00	1 0 - -	CA4-10	1SBN 010 110 R1010	1	0.014
AF09 ... AF38...-22-00	1 0 - -	CA4-10-T	1SBN 010 110 T1010	10	0.014
	0 1 - -	CA4-01	1SBN 010 110 R1001	1	0.014
	0 1 - -	CA4-01-T	1SBN 010 110 T1001	10	0.014
	2 2 - -	CA4-22E	1SBN 010 140 R1022	1	0.055
	3 1 - -	CA4-31E	1SBN 010 140 R1031	1	0.055
	4 0 - -	CA4-40E	1SBN 010 140 R1040	1	0.055
AF09 ... AF38...-40-00	0 4 - -	CA4-04E	1SBN 010 140 R1004	1	0.055

Front-mounted auxiliary contact blocks with N.O. leading contact and N.C. lagging contact

AF09 ... AF38...-40-00	- - 1 0	CC4-10	1SBN 010 111 R1010	1	0.014
AF09 ... AF38...-22-00	- - 0 1	CC4-01	1SBN 010 111 R1001	1	0.014

Side-mounted instantaneous auxiliary contact blocks

AF09 ... AF38...-40-00	1 1 - -	CAL4-11	1SBN 010 120 R1011	1	0.040
AF09 ... AF38...-22-00	1 1 - -	CAL4-11-T	1SBN 010 120 T1011	10	0.040

Front-mounted instantaneous auxiliary contact and A1/A2 coil terminal blocks

AF09 ... AF38...-40-00	1 1 - -	CAT4-11E	1SBN 010 151 R1011	1	0.040
AF09 ... AF38...-22-00					

Note: CAT4 not fittable on AF..Z contactors with DC control voltage 12...20VDC.



Technical Data

Types	1-pole CA4, 1-pole CC4, 4-pole CA4, 2-pole CAT4, 2-pole CAL4
-------	--

Contact Utilization Characteristics according to IEC

Standards	IEC 60947-5-1 and EN 60947-5-1	
Rated insulation voltage U_i acc. to IEC 60947-5-1	690 V	
Rated impulse withstand voltage U_{imp}	6 kV	
Rated operational voltage U_o max.	24 ... 690 V	
Conventional thermal current $I_{th} - \theta \leq 40^\circ\text{C}$	16 A	
Rated frequency limits	25 ... 400 Hz	
Rated operational current I_o / AC-15 acc. to IEC 60947-5-1	24-127 V 50/60 Hz	6 A
	220-240 V 50/60 Hz	4 A
	400-440 V 50/60 Hz	3 A
	500 V 50/60 Hz	2 A
	690 V 50/60 Hz	2 A
Making capacity acc. to IEC 60947-5-1	10 x I_o AC-15 acc. to IEC 60947-5-1	
Breaking capacity acc. to IEC 60947-5-1	10 x I_o AC-15 acc. to IEC 60947-5-1	
Rated operational current I_o / DC-13 acc. to IEC 60947-5-1	24 V DC	6 A / 144 W
	48 V DC	2.8 A / 134 W
	72 V DC	1 A / 72 W
	110 V DC	0.55 A / 60 W
	125 V DC	0.55 A / 69 W
	220 V DC	0.27 A / 60 W
	250 V DC	0.27 A / 68 W
	400 V DC	0.15 A / 60 W
	500 V DC	0.13 A / 65 W
600 V DC	0.1 A / 60 W	
Short-circuit protection gG type fuse	10 A	
Rated short-time withstand current I_{cw} $\theta = 40^\circ\text{C}$	for 1.0 s	100 A
	for 0.1 s	140 A
Minimum switching capacity with failure rate acc. to IEC 60947-5-4	12 V / 3 mA 10^{-7}	
Heat dissipation per pole at 6 A	0.1 W	
Mechanical durability	Number of operating cycles	10 millions operating cycles
	Max. switching frequency	3600 cycles/h
Max. electrical switching frequency	for AC-15	1200 cycles/h
	for DC-13	900 cycles/h

Contact Utilization Characteristics according to UL / CSA

Standards	UL 508, CSA C22.2 N°14
Rated insulation voltage U_i	600 V
Max. rated voltage	600 V AC, 600 V DC
Pilot duty	A600, Q600
AC thermal rated current	10 A
AC maximum volt-ampere making	7200 VA
AC maximum volt-ampere breaking	720 VA
DC thermal rated current	2.5 A
DC maximum volt-ampere making-breaking	69 VA

Connecting Characteristics

Screw terminals	(delivered in open position, screws of unused terminals must be tightened)	
All terminals	M3.5	
Connecting capacity (min. ... max.)		
Rigid solid	1 x	1 ... 2.5 mm ²
Flexible with non insulated ferrule	2 x	1 ... 2.5 mm ²
Flexible with insulated ferrule	1 x	0.75 ... 2.5 mm ²
Flexible with insulated ferrule	2 x	0.75 ... 2.5 mm ²
Flexible with insulated ferrule	1 x	0.75 ... 2.5 mm ²
Flexible with insulated ferrule	2 x	0.75 ... 1.5 mm ²
Bars or lugs	L <	8 mm
Capacity acc. to UL/CSA	1 or 2 x	AWG 18 ... 14
Stripping length	10 mm	
Degree of protection acc. to IEC 60947-1 / EN 60947-1 and IEC 60529 / EN 60529	IP20	
Screwdriver type	Flat Ø 5.5 / Pozidriv 2	
Tightening torque	1.2 Nm / 11 lb.in	

Accessories for AF09 ... AF38 4-pole Contactors

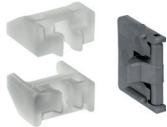

VM4

Mechanical interlock unit

Description

VM4 mechanical interlock unit for the interlocking of two AF contactors. When mounted between two contactors without additional width, the VM4 mechanical interlock unit prevents one of the contactors from closing as long as the other contactor is closed. The mechanical interlock unit includes 2 fixing clips (BB4).

Ordering Details

For contactors	Type	Order code	Pack ^(ing) pieces	Weight kg (1 pce)
AF09 ... AF38..-40-00	VM4	1SBN 030 105 T1000	10	0.005

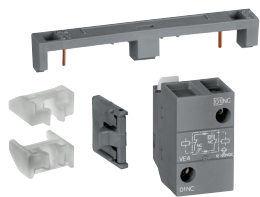

VEM4

Mechanical and electrical interlock set

Description

VEM4 mechanical and electrical interlock set for the interlocking of two AF contactors. **VEM4** set includes a mechanical interlock unit VM4 with 2 fixing clips (BB4) and a VE4 electrical interlock block with A2-A2 connection. Fixing the electrical interlock block to the contactor front face connects the 2 built-in N.C. interlocking contacts with the two coils. VE4 block must be used with A2-A2 connection to respect the electrical connection diagram.

Ordering Details

For contactors	Auxiliary contacts	Type	Order code	Pack ^(ing) pieces	Weight kg (1 pce)
AF09, AF16..-40-00 AF26, AF38..-40-00	1 1 	VEM4	1SBN 030 111 R1000	1	0.035

Note: VEM4 not fittable on AF..Z contactors with DC control voltage 12...20 V DC.

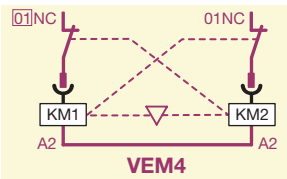

BB4

Fixing clips

Ordering Details

For contactors	Type	Order code	Pack ^(ing) pieces	Weight kg (1 pce)
AF09 ... AF38..-40-00	BB4	1SBN 110 120 W1000	50	0.002

Accessories for AF09 ... AF38 4-pole Contactors



Technical Data

Interlock types	VM4
Mechanical durability	
Number of operating cycles	5 millions operating cycles
Max. switching frequency	1800 cycles/h

Interlock types	VEM4
------------------------	-------------





Contact Utilization Characteristics according to IEC

Standards	IEC 60947-5-1 and EN 60947-5-1
Rated insulation voltage U_i acc. to IEC 60947-5-1	690 V
Rated impulse withstand voltage U_{imp}	6 kV
Rated control circuit voltage U_c	AC 50/60 Hz control voltage 24 ... 500 V AC
	DC control voltage 20 ... 500 V DC
Conventional thermal current $I_{th} - \theta \leq 40^\circ\text{C}$	16 A
Mechanical and electrical durability	
Number of operating cycles	5 millions operating cycles
Max. mechanical switching	1800 cycles/h
Max. electrical switching frequency	1200 cycles/h

Contact Utilization Characteristics according to UL / CSA

Standards	UL 508, CSA C22.2 N°14
Max. rated voltage	500 V AC, 500 V DC

Connecting Characteristics

Screw terminals	
All terminals	M3.5
Connecting capacity (min. ... max.)	
 Rigid Solid	1 x 1 ... 2.5 mm ² 2 x 1 ... 2.5 mm ²
 Flexible with non insulated ferrule	1 x 0.75 ... 2.5 mm ² 2 x 0.75 ... 2.5 mm ²
 Flexible with insulated ferrule	1 x 0.75 ... 2.5 mm ² 2 x 0.75 ... 1.5 mm ²
 Bars or lugs	L < 8 mm
Capacity according to UL/CSA	1 or 2 x AWG 18 ... 14
Stripping length	10 mm
Degree of protection	
acc. to IEC 60947-1 / EN 60947-1 and IEC 60529 / EN 60529	IP20
Screwdriver type	Flat Ø 5.5 / Pozidriv 2
Tightening torque	1.2 Nm / 11 lb.in

Accessories for AF09 ... AF38 4-pole Contactors



LDC4

Additional coil terminal block

Description

Additional coil terminal block for a bottom access to the coil terminals of contactors or contactor relays.

Ordering Details

For contactors	Type	Order code	Pack ^(ing) pieces	Weight kg (1 pce)
AF09 ... AF38	LDC4	1SBN 070 156 T1000	10	0.010



BX4



BX4-CA

Protective covers

Description

Sealable and transparent protective covers BX4 and non-removable BX4-CA to protect the devices against accidental contact.

Ordering Details

For contactors	Type	Order code	Pack ^(ing) pieces	Weight kg (1 pce)
All 1-stack contactors	BX4	1SBN 110 108 T1000	10	0.006
For 4-pole CA4 and 2-pole CAT4 auxiliary contact blocks	BX4-CA	1SBN 110 109 W1000	50	0.001

Function markers

Description

Box of 16 blank cards (16 markers by card) printable on HTP500 thermal transfer printer and AMS 500 marking table to identify your contactors, overload relays or manual motor starters.
Marker dimensions: 7 x 20 mm (.276" x .787")



BA4

Ordering Details

For contactors	Type	Order code	Pack ^(ing) pieces	Weight kg (1 pce)
Marker card	BA4	1SNA 235 156 R2700	16	0.011
AMS 500 support plate for 8 BA4	SPRC 1	1SNA 360 010 R1500	1	0.290
HTP500 support plate	HTP500-BA4	1SNA 235 712 R2400	1	0.220

Main Dimensions mm, inches

BX4

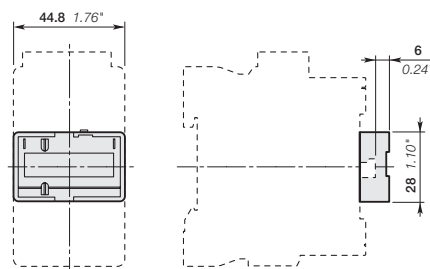

AF09 ... AF38 4-pole Contactors

Terminal Marking and Positioning

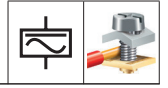

Standard devices without addition of auxiliary contacts

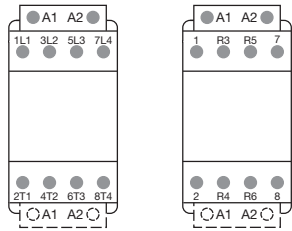

AF09 ... AF38..-40-00 AF09 ... AF38..-22-00

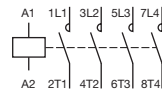

AF09 ... AF38..-40-00

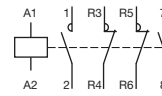

AF09 ... AF38..-22-00

Other possible contact combinations with auxiliary contacts added by the user

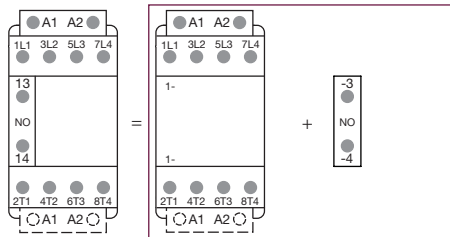

Combination 10 = AF09 ... AF38..-40-00 + CA4-10

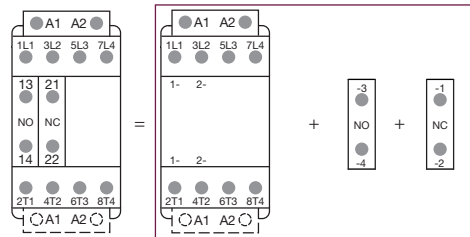

Combination 11 = AF09 ... AF38..-40-00+ CA4-10 + CA4-01

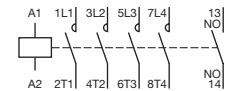

Combination 10

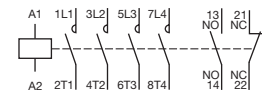

Combination 11

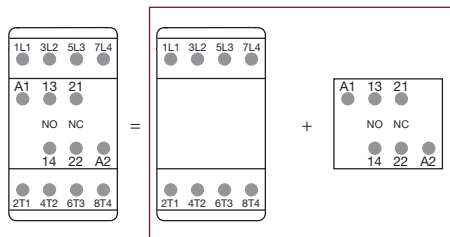

Combination 11 = AF09 ... AF38..-40-00 + CAT4-11E

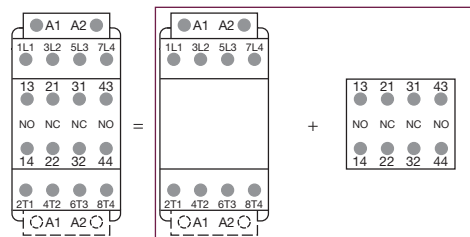

Combination 22 = AF09 ... AF38..-40-00 + CA4-22E

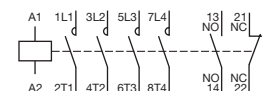

Combination 11

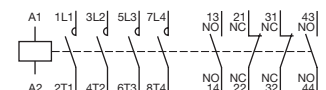

Combination 22

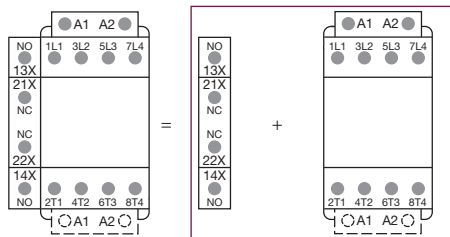

Combination 11 = CAL4-11 + AF09 ... AF38..-40-00

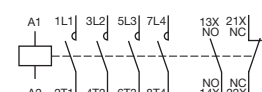

Combination 11

Note: Only AF.Z contactor with DC control voltage 12...20 V DC need to respect the connection polarities indicated close to the coil terminals: A1+ for the positive pole and A2- for the negative pole

Add-on Auxiliary Contacts

Terminal Marking and Positioning

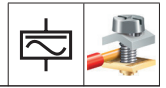

1-pole auxiliary contacts

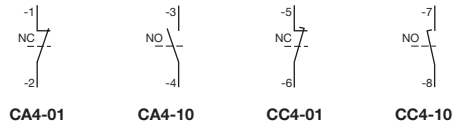

2-pole auxiliary contacts

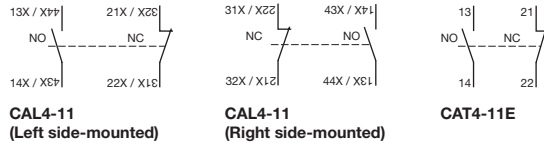

4-pole auxiliary contacts

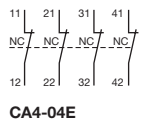
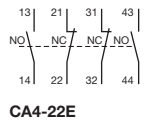
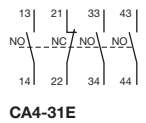
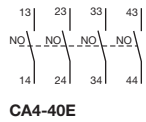

AF09, AF16 4-pole Contactors

AC / DC Operated - with Screw Terminals

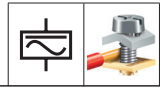

Dimensions mm, inches

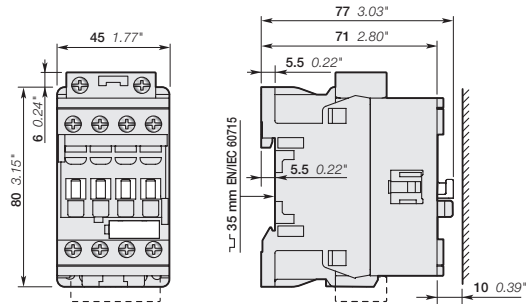

AF09, AF16

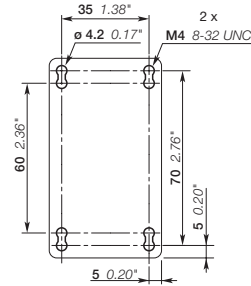

AF09, AF16

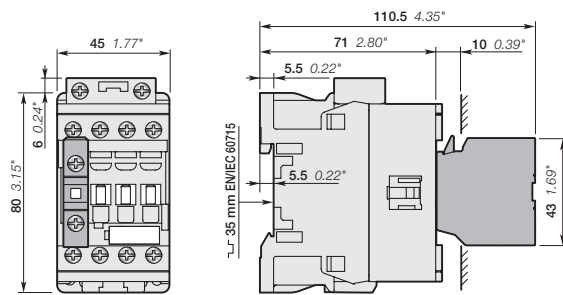

AF09, AF16
+ CA4, CC4 1-pole auxiliary contact block

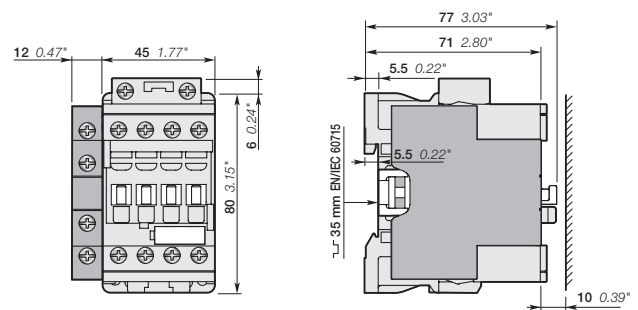

AF09, AF16
+ CAL4-11 2-pole auxiliary contact block

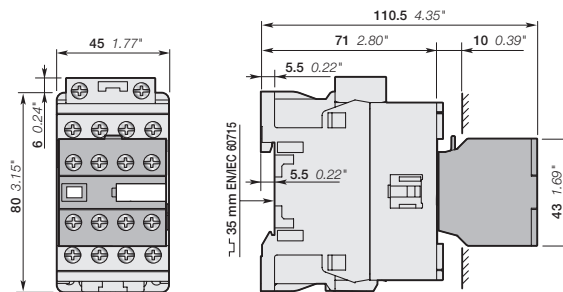

AF09, AF16
+ CA4 4-pole auxiliary contact block

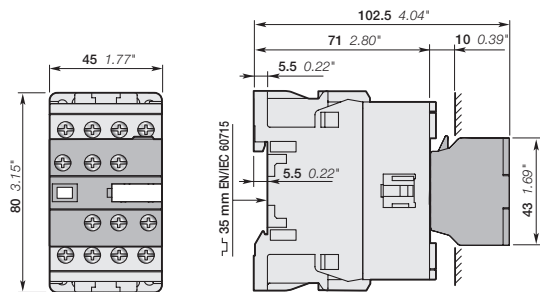

AF09, AF16
+ CAT4 2-pole auxiliary contact and coil terminal block

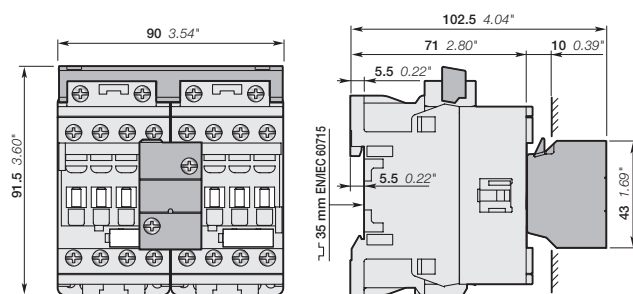

AF09..-40-00, AF16..-40-00
+ VEM4 mechanical and electrical interlock set

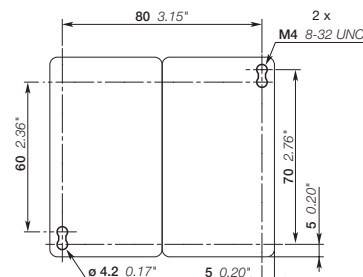

AF09..-40-00, AF16..-40-00
+ VEM4 mechanical and electrical interlock set

Note: contactor lateral distance to grounded component 2 mm 0.08" min.

AF26, AF38 4-pole Contactors

AC / DC Operated - with Screw Terminals



Dimensions mm, inches

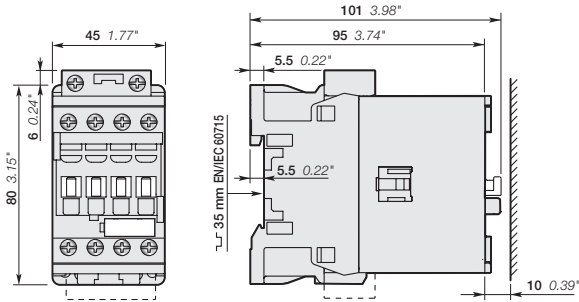

AF26, AF38

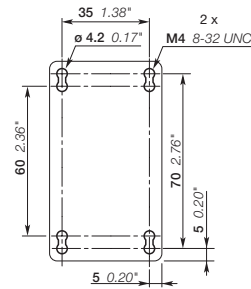

AF26, AF38

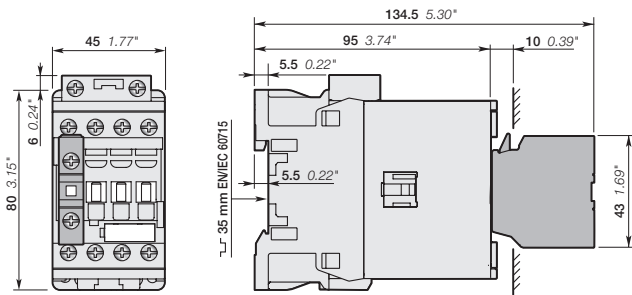

AF26, AF38
+ CA4, CC4 1-pole auxiliary contact block

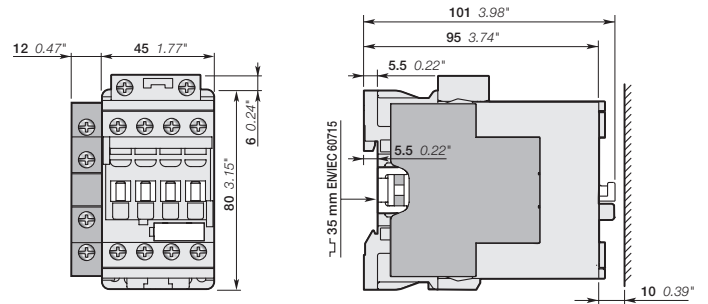

AF26, AF38
+ CAL4-11 2-pole auxiliary contact block

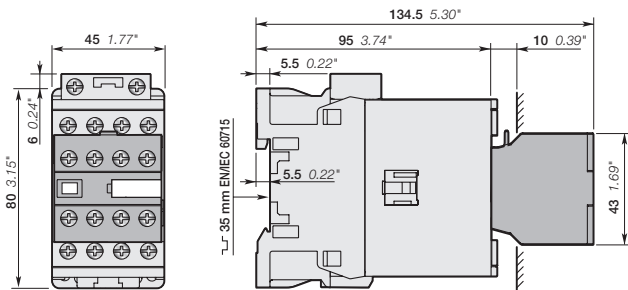

AF26, AF38
+ CA4 4-pole auxiliary contact block

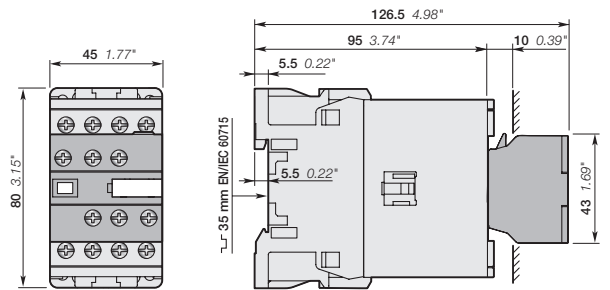

AF26, AF38
+ CAT4 2-pole auxiliary contact and coil terminal block

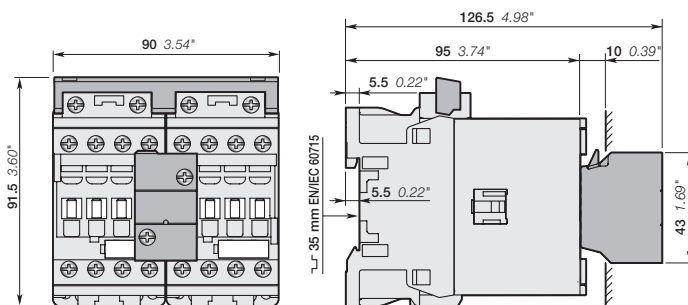

AF26..-40-00, AF38..-40-00
+ VEM4 mechanical and electrical interlock set

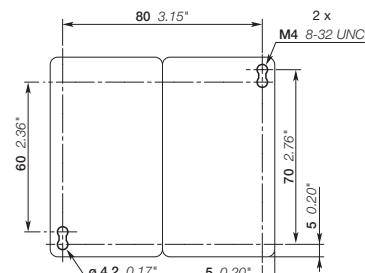

AF26..-40-00, AF38..-40-00
+ VEM4 mechanical and electrical interlock set

Note: contactor lateral distance to grounded component 2 mm 0.08" min.

Index

Order Code Classification

Order code	Type	Page	Order code	Type	Page	Order code	Type	Page	Order code	Type	Page
1SBL 136 201 R2000	AF09Z-40-00-20	6	1SBN 010 110 T1001	CA4-01-T	10						
1SBL 136 201 R2100	AF09Z-40-00-21	6	1SBN 010 110 T1010	CA4-10-T	10						
1SBL 136 201 R2200	AF09Z-40-00-22	6	1SBN 010 111 R1001	CC4-01	10						
1SBL 136 201 R2300	AF09Z-40-00-23	6	1SBN 010 111 R1010	CC4-10	10						
1SBL 136 501 R2000	AF09Z-22-00-20	6	1SBN 010 120 R1011	CAL4-11	10						
1SBL 136 501 R2100	AF09Z-22-00-21	6	1SBN 010 120 T1011	CAL4-11-T	10						
1SBL 136 501 R2200	AF09Z-22-00-22	6	1SBN 010 140 R1004	CA4-04E	10						
1SBL 136 501 R2300	AF09Z-22-00-23	6	1SBN 010 140 R1022	CA4-22E	10						
1SBL 137 201 R1100	AF09-40-00-11	5	1SBN 010 140 R1031	CA4-31E	10						
1SBL 137 201 R1200	AF09-40-00-12	5	1SBN 010 140 R1040	CA4-40E	10						
1SBL 137 201 R1300	AF09-40-00-13	5	1SBN 010 151 R1011	CAT4-11E	10						
1SBL 137 201 R1400	AF09-40-00-14	5	1SBN 030 105 T1000	VM4	12						
1SBL 137 501 R1100	AF09-22-00-11	5	1SBN 030 111 R1000	VEM4	12						
1SBL 137 501 R1200	AF09-22-00-12	5	1SBN 070 156 T1000	LDC4	14						
1SBL 137 501 R1300	AF09-22-00-13	5	1SBN 110 108 T1000	BX4	14						
1SBL 137 501 R1400	AF09-22-00-14	5	1SBN 110 109 W1000	BX4-CA	14						
1SBL 176 201 R2000	AF16Z-40-00-20	6	1SBN 110 120 W1000	BB4	12						
1SBL 176 201 R2100	AF16Z-40-00-21	6	1SNA 235 156 R2700	BA4	14						
1SBL 176 201 R2200	AF16Z-40-00-22	6	1SNA 235 712 R2400	HTP500-BA4	14						
1SBL 176 201 R2300	AF16Z-40-00-23	6	1SNA 360 010 R1500	SPRC 1	14						
1SBL 176 501 R2000	AF16Z-22-00-20	6									
1SBL 176 501 R2100	AF16Z-22-00-21	6									
1SBL 176 501 R2200	AF16Z-22-00-22	6									
1SBL 176 501 R2300	AF16Z-22-00-23	6									
1SBL 177 201 R1100	AF16-40-00-11	5									
1SBL 177 201 R1200	AF16-40-00-12	5									
1SBL 177 201 R1300	AF16-40-00-13	5									
1SBL 177 201 R1400	AF16-40-00-14	5									
1SBL 177 501 R1100	AF16-22-00-11	5									
1SBL 177 501 R1200	AF16-22-00-12	5									
1SBL 177 501 R1300	AF16-22-00-13	5									
1SBL 177 501 R1400	AF16-22-00-14	5									
1SBL 236 201 R2000	AF26Z-40-00-20	6									
1SBL 236 201 R2100	AF26Z-40-00-21	6									
1SBL 236 201 R2200	AF26Z-40-00-22	6									
1SBL 236 201 R2300	AF26Z-40-00-23	6									
1SBL 236 501 R2000	AF26Z-22-00-20	6									
1SBL 236 501 R2100	AF26Z-22-00-21	6									
1SBL 236 501 R2200	AF26Z-22-00-22	6									
1SBL 236 501 R2300	AF26Z-22-00-23	6									
1SBL 237 201 R1100	AF26-40-00-11	5									
1SBL 237 201 R1200	AF26-40-00-12	5									
1SBL 237 201 R1300	AF26-40-00-13	5									
1SBL 237 201 R1400	AF26-40-00-14	5									
1SBL 237 501 R1100	AF26-22-00-11	5									
1SBL 237 501 R1200	AF26-22-00-12	5									
1SBL 237 501 R1300	AF26-22-00-13	5									
1SBL 237 501 R1400	AF26-22-00-14	5									
1SBL 296 201 R2000	AF38Z-40-00-20	6									
1SBL 296 201 R2100	AF38Z-40-00-21	6									
1SBL 296 201 R2200	AF38Z-40-00-22	6									
1SBL 296 201 R2300	AF38Z-40-00-23	6									
1SBL 296 501 R2000	AF38Z-22-00-20	6									
1SBL 296 501 R2100	AF38Z-22-00-21	6									
1SBL 296 501 R2200	AF38Z-22-00-22	6									
1SBL 296 501 R2300	AF38Z-22-00-23	6									
1SBL 297 201 R1100	AF38-40-00-11	5									
1SBL 297 201 R1200	AF38-40-00-12	5									
1SBL 297 201 R1300	AF38-40-00-13	5									
1SBL 297 201 R1400	AF38-40-00-14	5									
1SBL 297 501 R1100	AF38-22-00-11	5									
1SBL 297 501 R1200	AF38-22-00-12	5									
1SBL 297 501 R1300	AF38-22-00-13	5									
1SBL 297 501 R1400	AF38-22-00-14	5									
1SBN 010 110 R1001	CA4-01	10									
1SBN 010 110 R1010	CA4-10	10									

Index

Type Classification

Type	Order code	Page	Type	Order code	Page	Type	Order code	Page	Type	Order code	Page
AF09-22-00-11	1SBL 137 501 R1100	5	BX4	1SBN 110 108 T1000	14						
AF09-22-00-12	1SBL 137 501 R1200	5	BX4-CA	1SBN 110 109 W1000	14						
AF09-22-00-13	1SBL 137 501 R1300	5	CA4-01	1SBN 010 110 R1001	10						
AF09-22-00-14	1SBL 137 501 R1400	5	CA4-01-T	1SBN 010 110 T1001	10						
AF09-40-00-11	1SBL 137 201 R1100	5	CA4-04E	1SBN 010 140 R1004	10						
AF09-40-00-12	1SBL 137 201 R1200	5	CA4-10	1SBN 010 110 R1010	10						
AF09-40-00-13	1SBL 137 201 R1300	5	CA4-10-T	1SBN 010 110 T1010	10						
AF09-40-00-14	1SBL 137 201 R1400	5	CA4-22E	1SBN 010 140 R1022	10						
AF09Z-22-00-20	1SBL 136 501 R2000	6	CA4-31E	1SBN 010 140 R1031	10						
AF09Z-22-00-21	1SBL 136 501 R2100	6	CA4-40E	1SBN 010 140 R1040	10						
AF09Z-22-00-22	1SBL 136 501 R2200	6	CAL4-11	1SBN 010 120 R1011	10						
AF09Z-22-00-23	1SBL 136 501 R2300	6	CAL4-11-T	1SBN 010 120 T1011	10						
AF09Z-40-00-20	1SBL 136 201 R2000	6	CAT4-11E	1SBN 010 151 R1011	10						
AF09Z-40-00-21	1SBL 136 201 R2100	6	CC4-01	1SBN 010 111 R1001	10						
AF09Z-40-00-22	1SBL 136 201 R2200	6	CC4-10	1SBN 010 111 R1010	10						
AF09Z-40-00-23	1SBL 136 201 R2300	6	HTP500-BA4	1SNA 235 712 R2400	14						
AF16-22-00-11	1SBL 177 501 R1100	5	LDC4	1SBN 070 156 T1000	14						
AF16-22-00-12	1SBL 177 501 R1200	5	SPRC 1	1SNA 360 010 R1500	14						
AF16-22-00-13	1SBL 177 501 R1300	5	VEM4	1SBN 030 111 R1000	12						
AF16-22-00-14	1SBL 177 501 R1400	5	VM4	1SBN 030 105 T1000	12						
AF16-40-00-11	1SBL 177 201 R1100	5									
AF16-40-00-12	1SBL 177 201 R1200	5									
AF16-40-00-13	1SBL 177 201 R1300	5									
AF16-40-00-14	1SBL 177 201 R1400	5									
AF16Z-22-00-20	1SBL 176 501 R2000	6									
AF16Z-22-00-21	1SBL 176 501 R2100	6									
AF16Z-22-00-22	1SBL 176 501 R2200	6									
AF16Z-22-00-23	1SBL 176 501 R2300	6									
AF16Z-40-00-20	1SBL 176 201 R2000	6									
AF16Z-40-00-21	1SBL 176 201 R2100	6									
AF16Z-40-00-22	1SBL 176 201 R2200	6									
AF16Z-40-00-23	1SBL 176 201 R2300	6									
AF26-22-00-11	1SBL 237 501 R1100	5									
AF26-22-00-12	1SBL 237 501 R1200	5									
AF26-22-00-13	1SBL 237 501 R1300	5									
AF26-22-00-14	1SBL 237 501 R1400	5									
AF26-40-00-11	1SBL 237 201 R1100	5									
AF26-40-00-12	1SBL 237 201 R1200	5									
AF26-40-00-13	1SBL 237 201 R1300	5									
AF26-40-00-14	1SBL 237 201 R1400	5									
AF26Z-22-00-20	1SBL 236 501 R2000	6									
AF26Z-22-00-21	1SBL 236 501 R2100	6									
AF26Z-22-00-22	1SBL 236 501 R2200	6									
AF26Z-22-00-23	1SBL 236 501 R2300	6									
AF26Z-40-00-20	1SBL 236 201 R2000	6									
AF26Z-40-00-21	1SBL 236 201 R2100	6									
AF26Z-40-00-22	1SBL 236 201 R2200	6									
AF26Z-40-00-23	1SBL 236 201 R2300	6									
AF38-22-00-11	1SBL 297 501 R1100	5									
AF38-22-00-12	1SBL 297 501 R1200	5									
AF38-22-00-13	1SBL 297 501 R1300	5									
AF38-22-00-14	1SBL 297 501 R1400	5									
AF38-40-00-11	1SBL 297 201 R1100	5									
AF38-40-00-12	1SBL 297 201 R1200	5									
AF38-40-00-13	1SBL 297 201 R1300	5									
AF38-40-00-14	1SBL 297 201 R1400	5									
AF38Z-22-00-20	1SBL 296 501 R2000	6									
AF38Z-22-00-21	1SBL 296 501 R2100	6									
AF38Z-22-00-22	1SBL 296 501 R2200	6									
AF38Z-22-00-23	1SBL 296 501 R2300	6									
AF38Z-40-00-20	1SBL 296 201 R2000	6									
AF38Z-40-00-21	1SBL 296 201 R2100	6									
AF38Z-40-00-22	1SBL 296 201 R2200	6									
AF38Z-40-00-23	1SBL 296 201 R2300	6									
BA4	1SNA 235 156 R2700	14									
BB4	1SBN 110 120 W1000	12									

Contact us

ABB France

Low Voltage Products Division

10, rue Ampère Z.I. - B.P. 114
F-69685 Chassieu cedex / France

ABB STOTZ-KONTAKT GmbH

Eppelheimer Straße 82
D-69123 Heidelberg / Germany

ABB AB/ Cewe-Control

Motorgränd 20
S-721 61 Västerås / Sweden

You can find the address of your local sales organisation
on the ABB home page

<http://www.abb.com/contacts> -> Low Voltage products

Note

We reserve the right to make technical changes or modify the contents of this document without prior notice. With regard to purchase orders, the agreed particulars shall prevail. ABB does not accept any responsibility whatsoever for potential errors or possible lack of information in this document.

We reserve all rights in this document and in the subject matter and illustrations contained therein. Any reproduction, disclosure to third parties or utilization of its contents – in whole or in parts – is forbidden without prior written consent of ABB.

Copyright© 2010 ABB
All rights reserved